

# Solar Attic Fan Garage Vent Kit

www.rewci.com



**IMPORTANT:** Please take the time to read through the ENTIRE instructions prior to starting any work. These instructions include the installation of the Solar Attic Fan unit which is sold separately.

**PLEASE READ:** The Solar Attic Fan Garage Vent Kit has an optional ceiling radiation damper which is required in some locations to protect against fire and heat radiation. Please check with your local building codes to see if your installation requires a radiation damper.

## TOOLS NEEDED

- Reciprocating Saw
- Measuring Tape
- Driver & Bits
- Phillips Screwdriver
- Caulking Gun
- Stud Finder
- Marking Pencil
- Ladders
- Safety Goggles
- Drywall Saw
- Utility Knife

## PARTS LIST

- A.** Solar Attic Fan Unit
- B.** (6) Phillips Head Stainless Steel 1 1/2" Screws
- C.** (7) Phillips Head Stainless Steel 1/2" Self-Tapping Screws
- D.** 5" Adapter Sleeve
- E.** (2) Stainless Steel Straps
- F.** Flexible Duct Pipe - 8 feet
- G.** 3" Adapter Sleeve
- H.** (3) Black Speed Nuts
- I.** Ceiling Ring
- J.** (3) 1 1/2" Flat Head Phillips Screws
- K.** Mesh Vent Screen
- L.** White Powder Coated Aluminum Trim Ring
- M.** Caulk

\*A, B and M are the parts of the Solar Attic Fan unit sold separately

## OPTIONAL RADIATION DAMPER

(Replaces 3" Adapter Sleeve - Part G)

- a.** U.L. Listed Fusible Link (212°F)
- b.** Damper Sleeve

## CHOOSING LOCATION FOR UNIT

Southern exposure is best when choosing a location for installing the solar attic fan. If a southern exposure is not feasible for your installation, the fan can be installed on any other exposure and the solar panel adjusted to capture maximum sunlight.

**IMPORTANT:** The ceiling ring vent should be installed directly under the solar attic fan unit to maximize venting capacity.

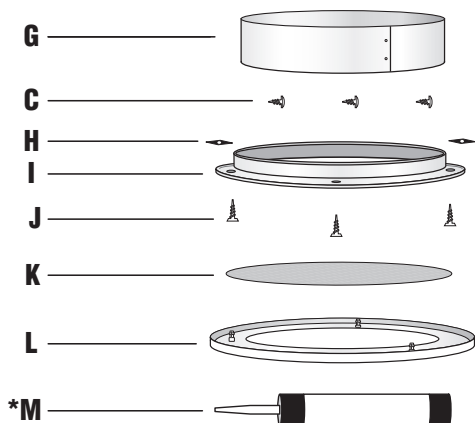
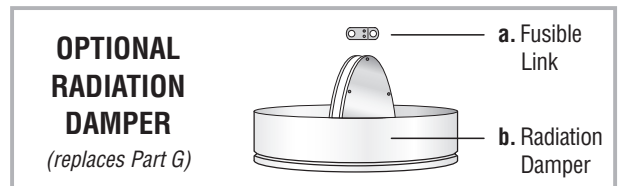
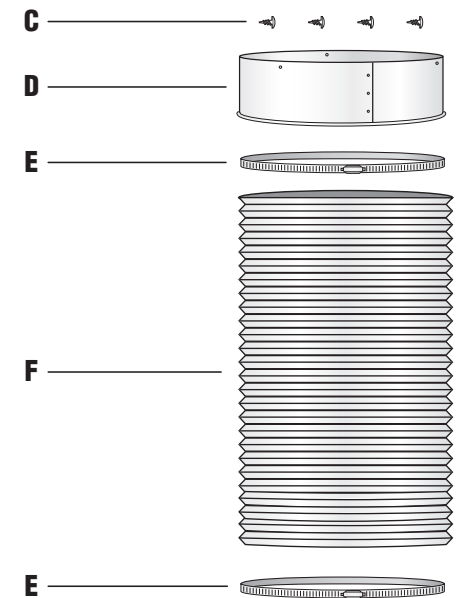
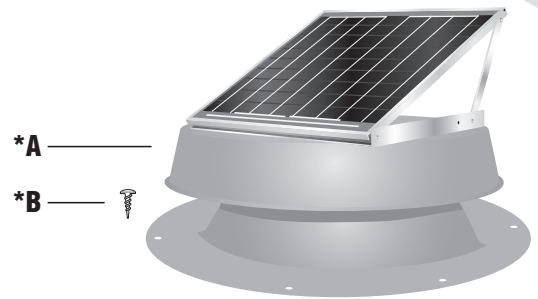

## Step 1

To facilitate installation, once the desired location is obtained, ensure that there are no obstructions in the attic between the roof and ceiling. With a stud finder locate the ceiling joists and center ceiling ring between joists as close to the desired installation area as possible. Mark the center of the ceiling ring, drill a hole and insert piece of wire bent at a 90 degree angle. Rotate the wire around 360 degrees. While rotating, feel for resistance that could indicate wire runs or other obstructions.

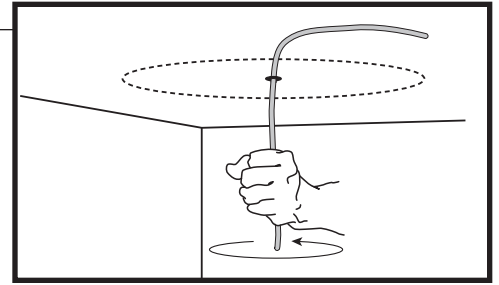

## Step 2

If there are no obstructions, mark **INSIDE** of the 3" adapter sleeve (**G**) on to the ceiling, see **diagram**. Using a drywall saw, cut out the scribed mark in the ceiling. The opening should be 13.5" in diameter to accommodate the adapter sleeve.

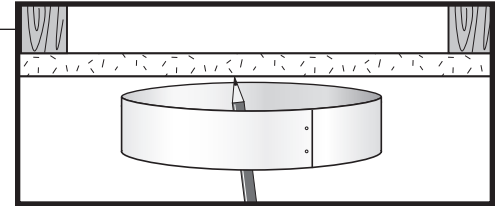

## Step 3

For the roof penetration, place a step ladder under the ceiling hole and place a flashlight on top of the ladder, the resulting flashlight beam will mark the location for the centering hole of the flashing unit on the roof. With a drill bit and appropriate extension rods, drill a pilot hole in the marked location on the bottom side of the roof. If the attic space is accessible, a plumb-bob may also be used.

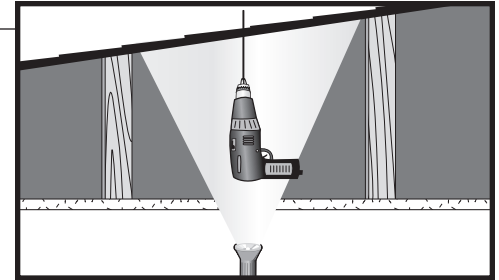

## Step 4

On the roof, locate the centering hole drilled in Step 3. Hammer a nail at the center of the location chosen between rafters for the solar attic fan. The center of the unit should be about 2 feet down from the ridge. Attach a string to the nail. Measure 7" of string and attach a marking pen to the string. Scribe a 14" circle onto the roof shingles.

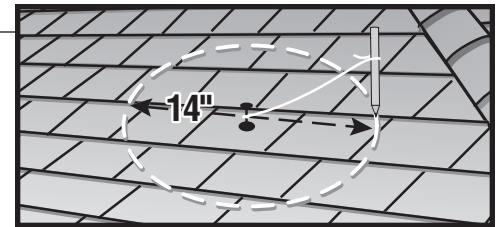

## Step 5

With a reciprocating saw, cut the diameter of the hole. **NEVER CUT THROUGH ANY ROOF RAFTERS. LEAVE ALL FRAMING MEMBERS IN PLACE.**

**IMPORTANT:** The solar attic fan garage vent must be installed between the roof rafters. **DO NOT CUT THROUGH ANY FRAMING MEMBER.** Only remove roof sheathing.

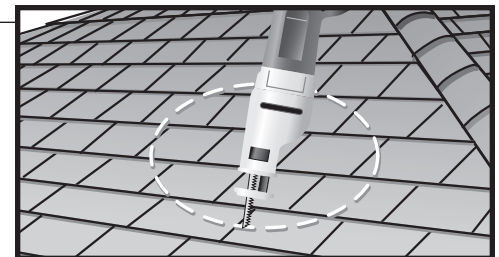

## Step 6

With a razor knife, cut a four inch slit through the shingles and tar paper at the three and nine o'clock position of the flashing. This allows for the foot print of the flashing to be inserted under the shingles. Additional shingles may also need to be removed on the high side towards the ridge to allow the flashing to slide over the hole.

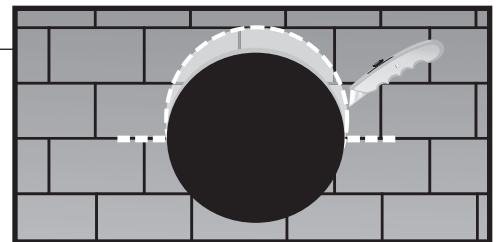

## Step 7

Insert the reciprocating saw blade sideways at the 3:00 o'clock position and cut the roofing nails up and around to the 9:00 o'clock position. This process removes the nails that will prevent the flashing footprint from sliding up underneath the shingles.

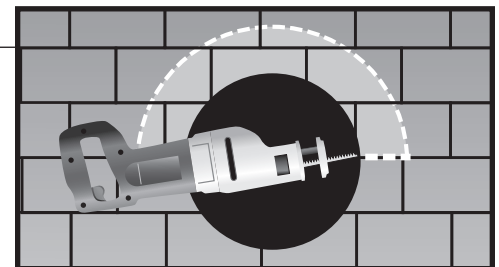

## Step 8

Slip on one end of the flexible duct pipe (F) over the end of the 5" adapter sleeve (D) with the grooved edge. Loosen clamp on one of the stainless steel straps (E) using a Philips head screwdriver. Slide strap over the end of the flexible pipe where it meets the adapter sleeve and secure strap (see inset).

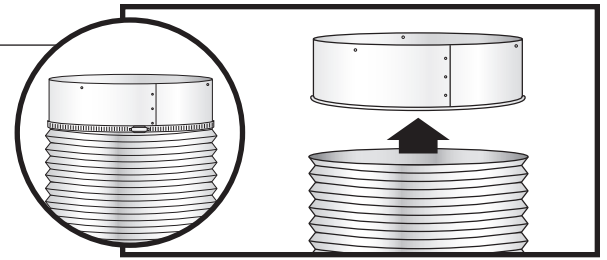

## Step 9

Carefully turn upside-down the solar attic fan unit (A) using caution to not damage the solar panel. Grab the 5" adapter sleeve assembled in the previous step, and slide it into the opening on the bottom of the solar attic fan. Push adapter sleeve until it stops on the fan housing brackets inside the attic fan. Using the (4) ¼" self-tapping screws (C), attach the adapter sleeve to the side of the solar attic fan through the pre-drilled holes on the tube adapter.

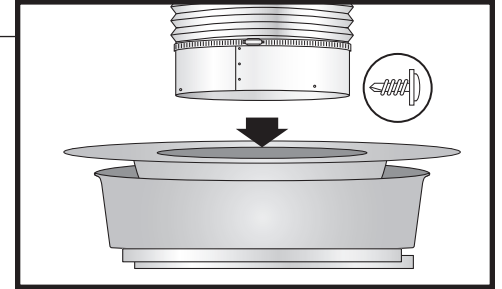

## Step 10

Assure that the flexible pipe is compacted and sitting directly over the fan opening of the solar attic fan unit. Caulk the **underside** of the flashing with the provided caulking material (M). Two concentric rings of caulking material is sufficient.

**NOTE:** Installation on tile roofs will require the use of a skirt.

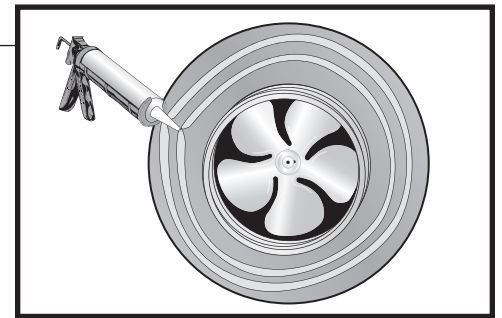

## Step 11

With the flexible pipe compacted as much as possible and taking care not to smear caulk on the exposed shingles, slide flashing under tar paper and shingles and force flashing up until the shingles come in contact with the raised portion of the flashing. The bottom side of the flashing will be on top of the shingles. Secure flashing with provided (6) Phillips head screws (B) through the predrilled holes on the flashing footprint. (If needed, additional screws can be added by installer. **NOTE:** The flexible pipe should fall through the attic roof opening making it accessible from the garage ceiling.

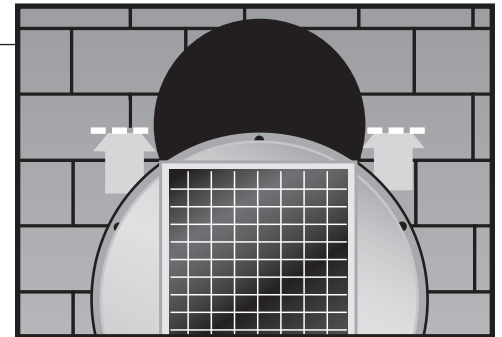

## Step 12

Caulk over the screw heads that are exposed to the weather. Use the remaining caulk to seal the areas where the 4" slits were made and around the area where the shingles meet with the raised area of the flashing.

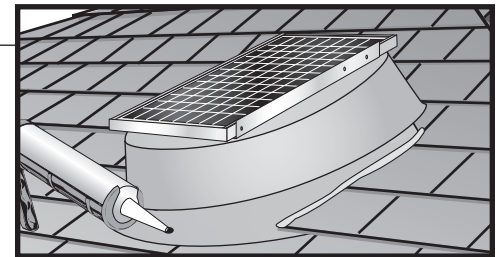

## Step 13

Loosen and remove the two self-tapping screws attached to the solar panel bracket. Adjust the solar panel to the position it will collect the most sunlight throughout the day and replace the screws making sure the screws do not damage the solar panel.

**NOTE:** Some 10 watt panels may have a clip/screw assembly. To adjust panel on these units, **loosen, but do not remove**, the assembly located on each side of the solar panel bracket. Adjust the solar panel to desired position and tighten screws (see inset).

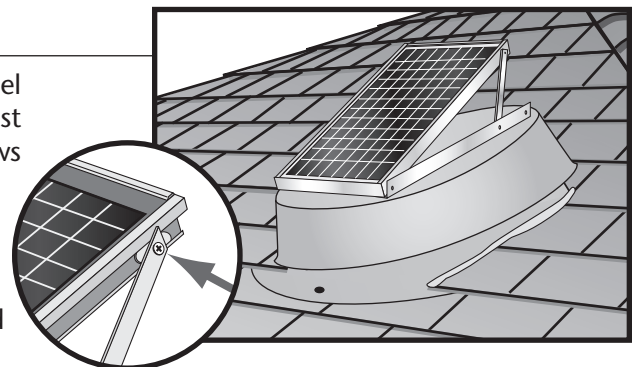

**IMPORTANT NOTE:** Use Step 15 for a standard installation and use Steps 15A and 15B for installing the radiation damper. This step can be done from the inside the attic if there is access.

## Step 15 - Standard Installation

Inside the garage, place the 3" adapter sleeve (G) and the other stainless steel strap (E) through the hole cut in the ceiling and temporarily place off to the side in the attic space. Locate the flexible pipe that should be hanging from the solar attic fan unit on the roof. Slip the flexible pipe over the end of the 3" adapter sleeve. Loosen clamp on the stainless steel strap (E) using a Philips head screwdriver. Slide strap over the end of the flexible pipe where it meets the adapter sleeve and secure strap.

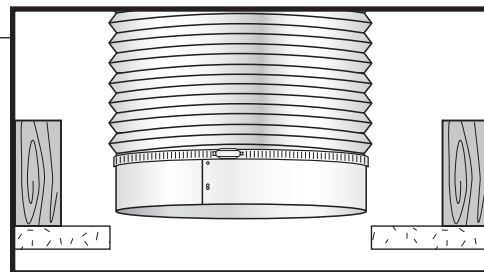

## Step 15A - Radiation Damper Installation

Remove gold color fuse link (a) from the plastic bag attached to the radiation damper (b). With one hand, firmly grab the radiation damper and with other hand squeeze the spring load damper blade halves together and hold. Thread one of the holes on the fuse link through the loop hook on the damper blade and the other hole into the top hook on other blade (see inset). **NOTE:** Use caution when working the damper blades - they are spring-loaded and can snap shut if not held firmly.

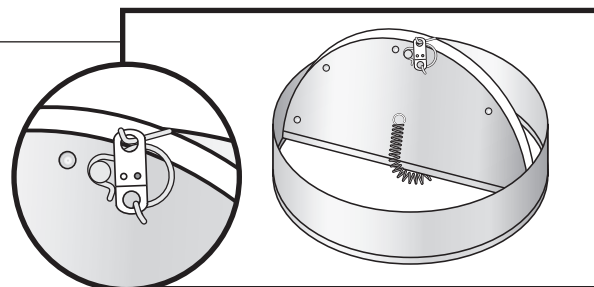

## Step 15B - Radiation Damper Installation

Inside the garage, place the assembled radiation damper and a stainless steel strap (E) through the hole cut in the garage ceiling and temporarily place off to the side in the attic space. Locate the flexible pipe that should be hanging from the solar attic fan unit on the roof. Slip the flexible pipe over the end of the radiation damper with the grooved end down. Loosen clamp on one of the stainless steel straps (E) using a Philips head screwdriver. Slide strap over the end of the flexible pipe where it meets the radiation damper and secure strap.

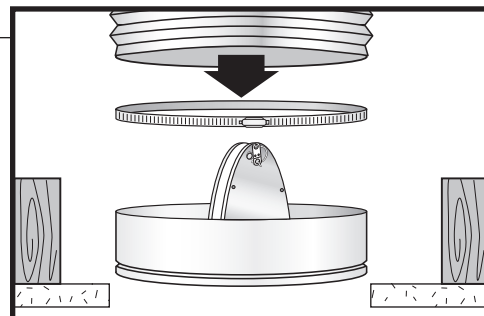

## Step 16

Secure the ceiling ring (I) to ceiling by inserting a screw (J) into one of the three smaller non-dimpled pre-drilled holes and screwing it up through the drywall into one of the speed nuts (H) provided. Repeat this process for all three screws.

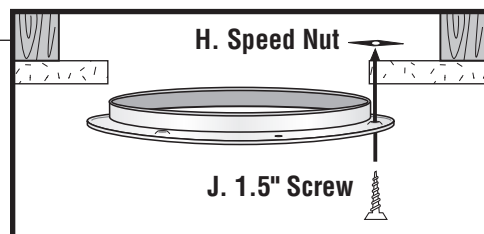

## Step 17

Reach through the ceiling collar up into the attic and grab the adapter sleeve (or radiation damper) assembly. Slide the adapter sleeve (or damper) over the **outside** of the ceiling collar (see inset). Secure the ceiling collar to the adapter sleeve (or damper) using (3) 1/2" self-tapping screws (C) through the pre-drilled holes.

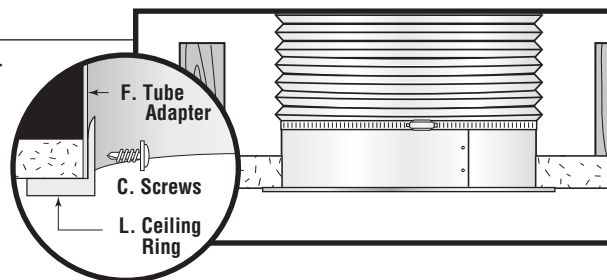

## Step 18

Place mesh vent screen (K) into the white trim ring (L). Line up the three steel pins on the trim ring with the holes on the bottom of the ceiling collar. Push up on trim ring to snap into place.

